

AWS Group





Our group service



- Design & Software
- Fabrication and modification
- Assembly and set up



- Industrial supply / trading





Company Profile



Advanced & Wise Solution Co., Ltd.

Address: 45/1243 Moo7 DK Village Soi 16

Kanchanapisek Rd., Bangbon

Bangkok 10150

Tel: 02-417-8600-2

Fax: 02-417-8603

H/P: 081-752-3499

Factory Area: 264 Sq-m + 50 Sq-m

Paid Up Capital : 1.5 Million Baht



Mission and Vision

Mission.

& Customer successful and satisfaction.

Vision.

& To be a supplier of choice and leading company of engineering, coaching for improving quality.

& The work or business of offering expert advice.





Company Background

Advanced & Wise Solution was established by a team of highly performance and experience in

- Mechanical Engineer
- Industrial Engineer
- Electrical Engineer
- Software Engineer
- Marketing specialist

We have more than 10 years experienced in tooling/equipment/machine design and replication.





Organization

Advanced & Wise Solution Co., Ltd.



Man power	27
Managing Director	1
Manager	4
Supervisor	1
Engineer	7
Technician	11
Admin.	3

Up Date 22/Apr/20

AWS Group



Management team



M. Mechanical Eng.
(Kasetsart Univ.)

B. Mechanical Eng.
(Tech. Ratchamongkol)

Managing Director



M. Business Administration
(Ramkhamhang Univ.)

B. Industrial Eng.
(Tech. Ratchamongkol)

Production Manager



B. Electronic Eng.
(Khonkaen Univ.)

Engineering Manager



B. Electrical Eng.
(Chulalongkorn Univ.)

Marketing Manager / QMR





Products & Services

Industrial
Equipment supply

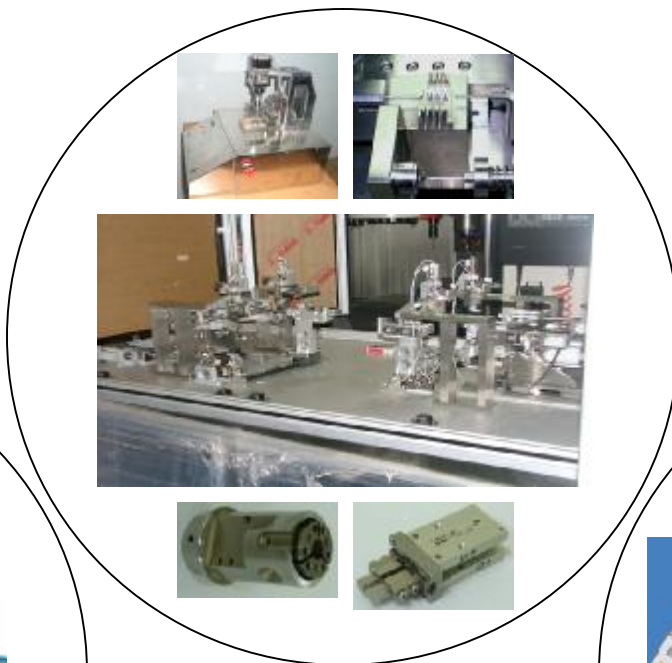

Design/Software

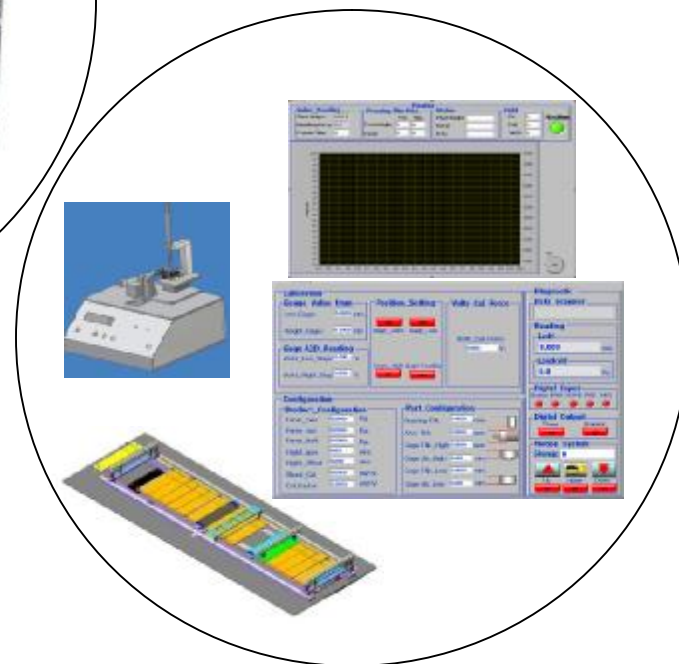

Fabrication &
Modification





Quality management system

ISO 9001 activities.

- Enrolled the TLC ISO 9001:2000 program in Jan, 2008.
- 1st stage audit (Pre-assessment) by TISTR on Nov 18, 2008,
- 2nd stage audit (Final assessment) for ISO9001:2008 on Jun 24, 2009.
- ISO 0991:2008 Certified on Aug 14, 2009





Outsourcing process

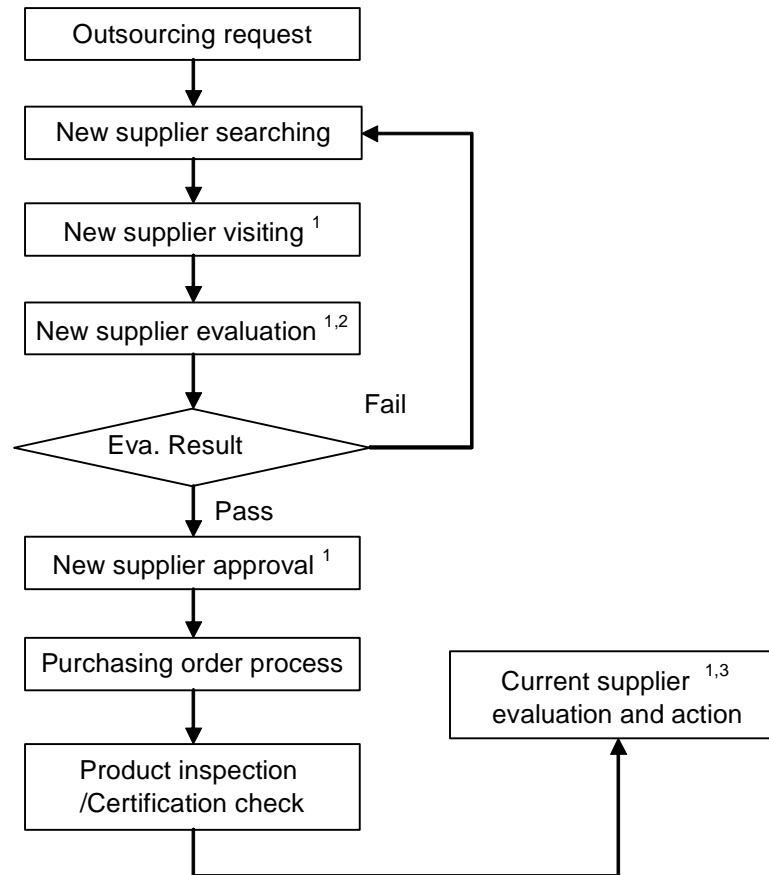

1 - See QP-AD-03 (Purchasing and outsourcing procedure)

2 - See FM-AD-20 (New supplier evaluation form)

3 - See FM-AD-21 (Current supplier evaluation form)





Design

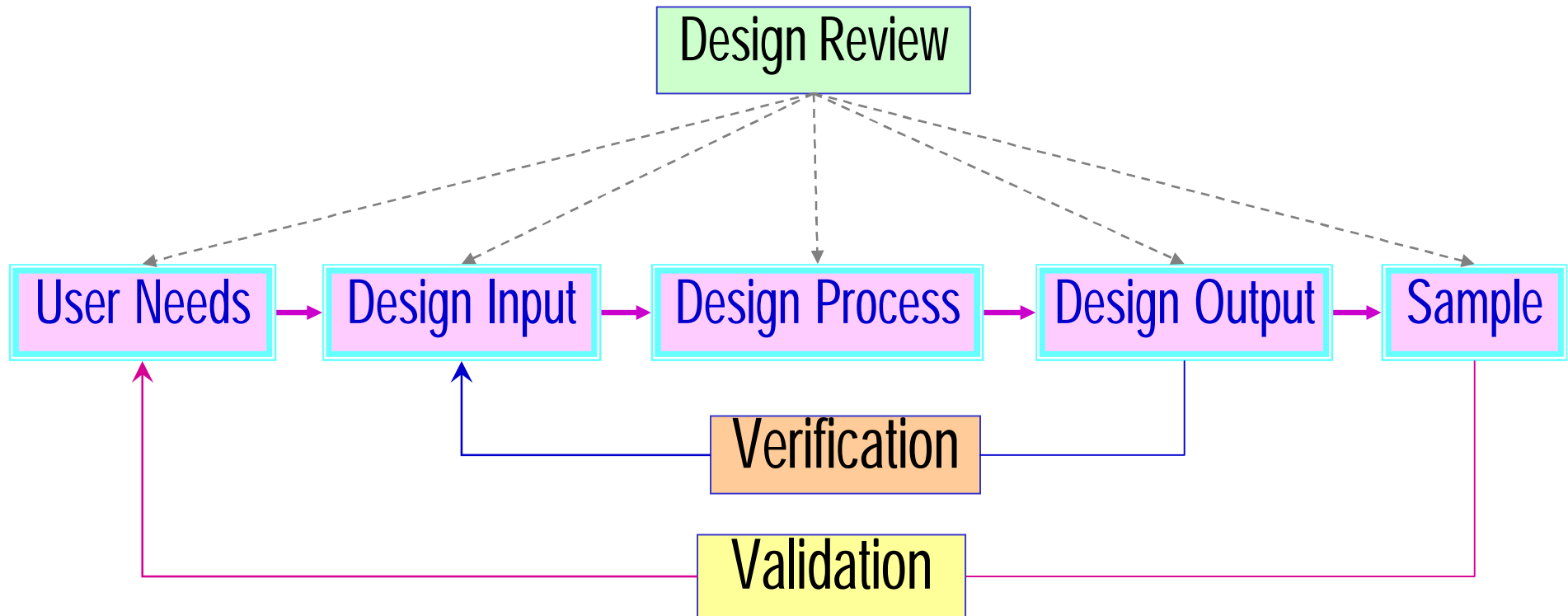

- Machine design
- Main feature
 - Environmental health & Safety
 - Maintenance
 - Reliability

- Fabrication part design
- Material
 - GD&T
 - Finishing process
 - Machining capability

- Equipment selection
- Engineering parameter
 - Reliability
 - Easy to find
 - Cost

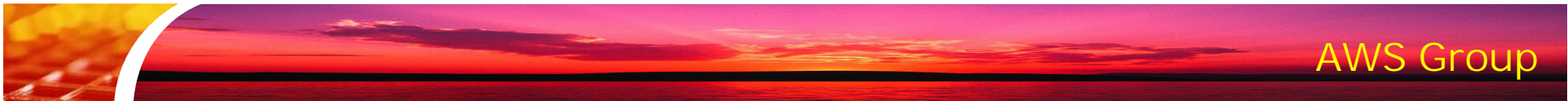



Design experience

- Pivot installation machine.
(Installation accuracy 10 micron and force control)
- Cutting IC Leg machine.
(Cutting accuracy 100 micron)
- Bending IC machine.
(Bending accuracy 200 micron)
- HSA tray conveyor line.
- Upgrade G1 Embedding machine
- Automotive part inspection machine
- Vision inspection / OCR



Design experience (Semi-Auto assy)

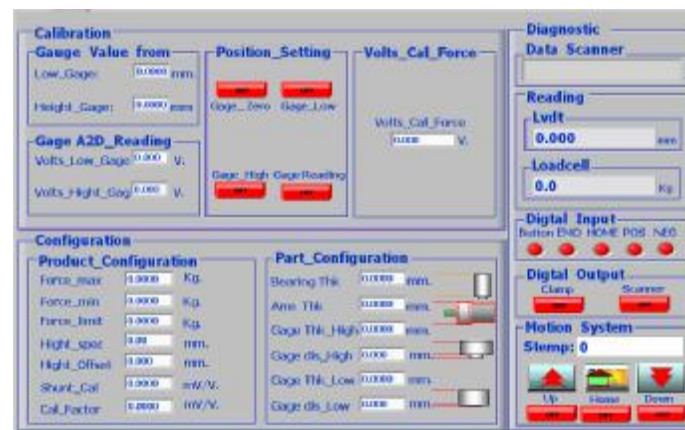
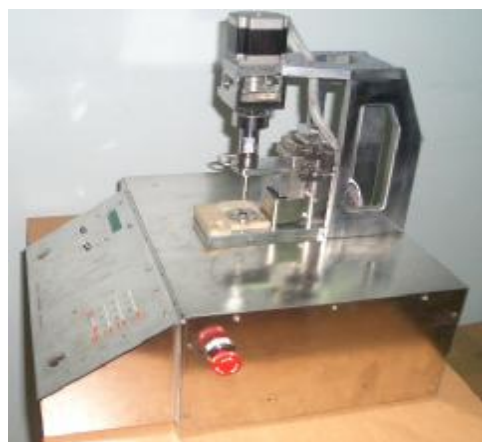
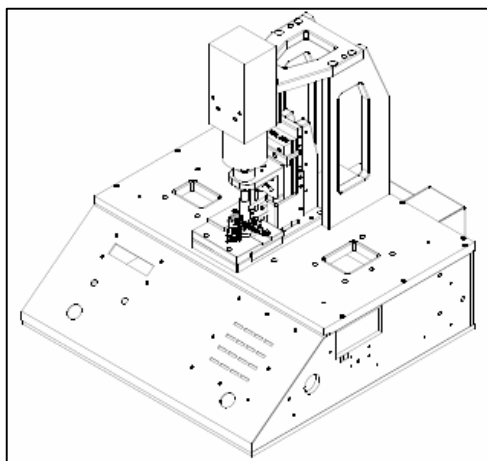

Pivot installation machine

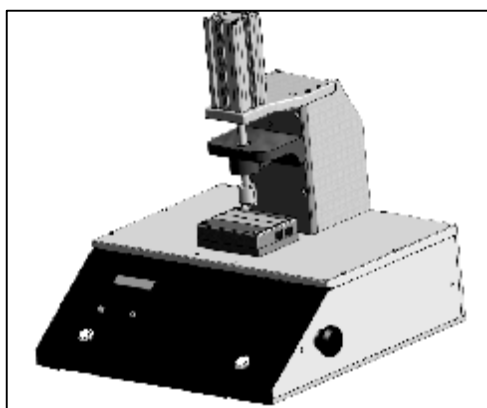

Cutting IC machine



Design experience (Conveyor)

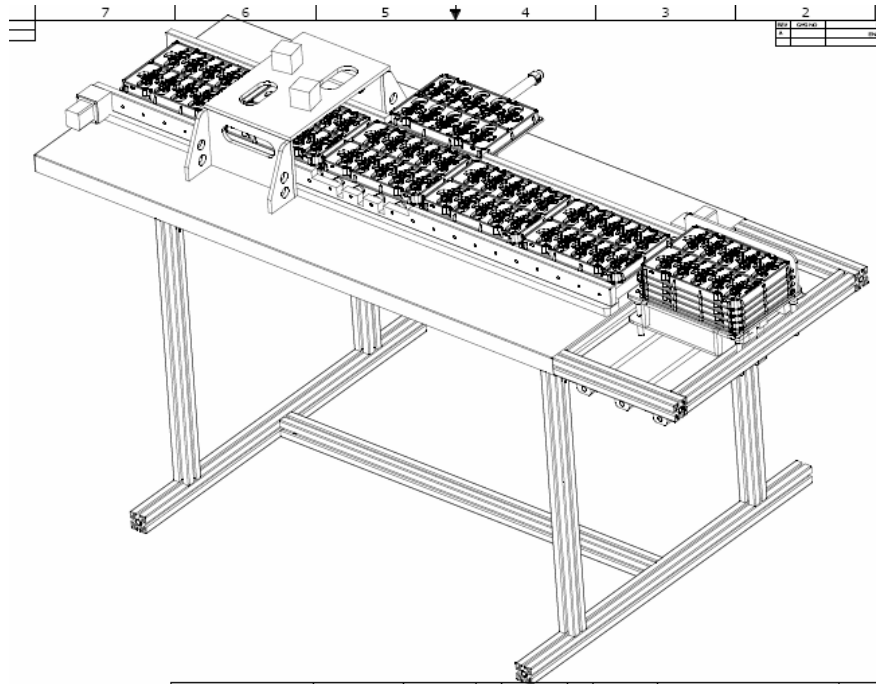

HSA tray conveyor line





Design experience (Inspection)

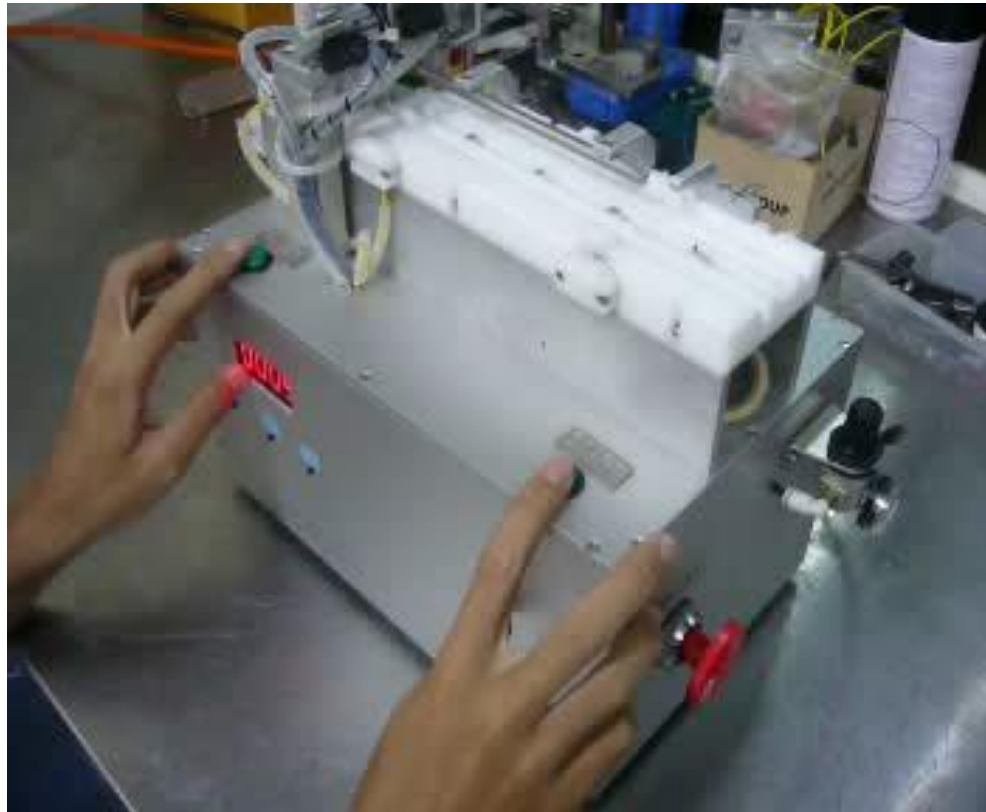

Automotive part inspection machine



Design experience (Inspection)

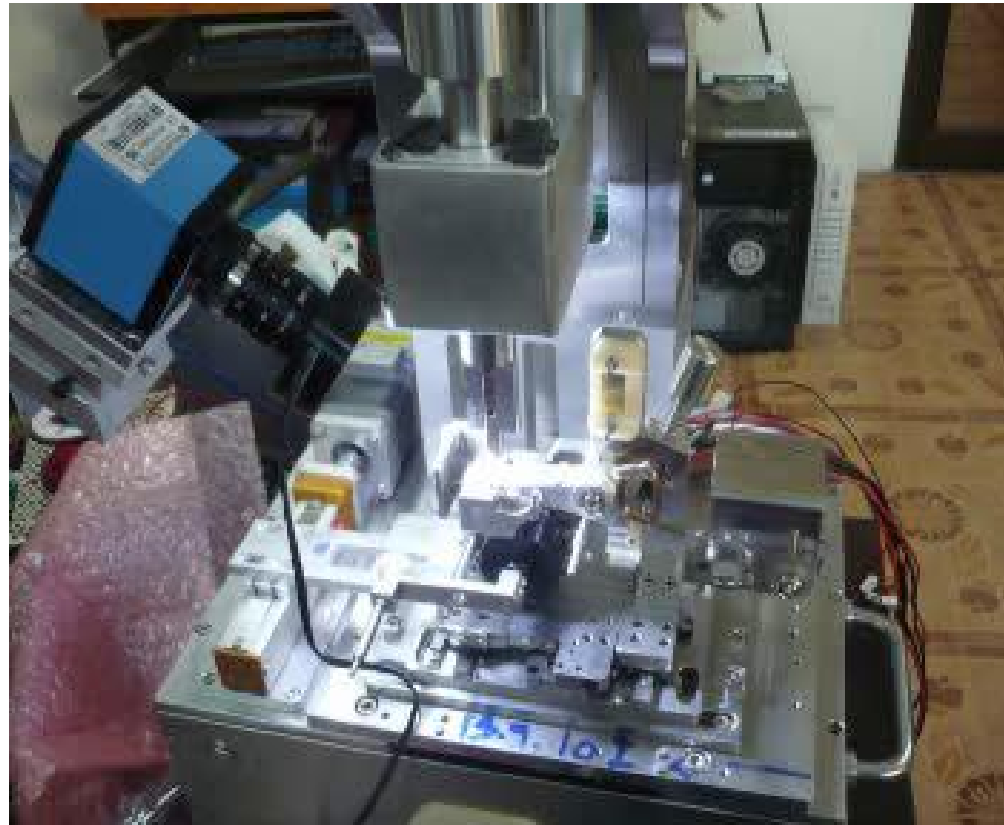

Automotive part inspection machine



Design experience (Vision)

Part Inspection

Rubber ring installation

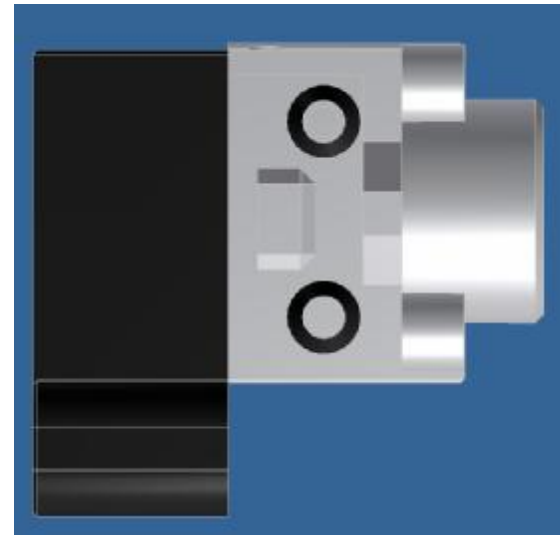
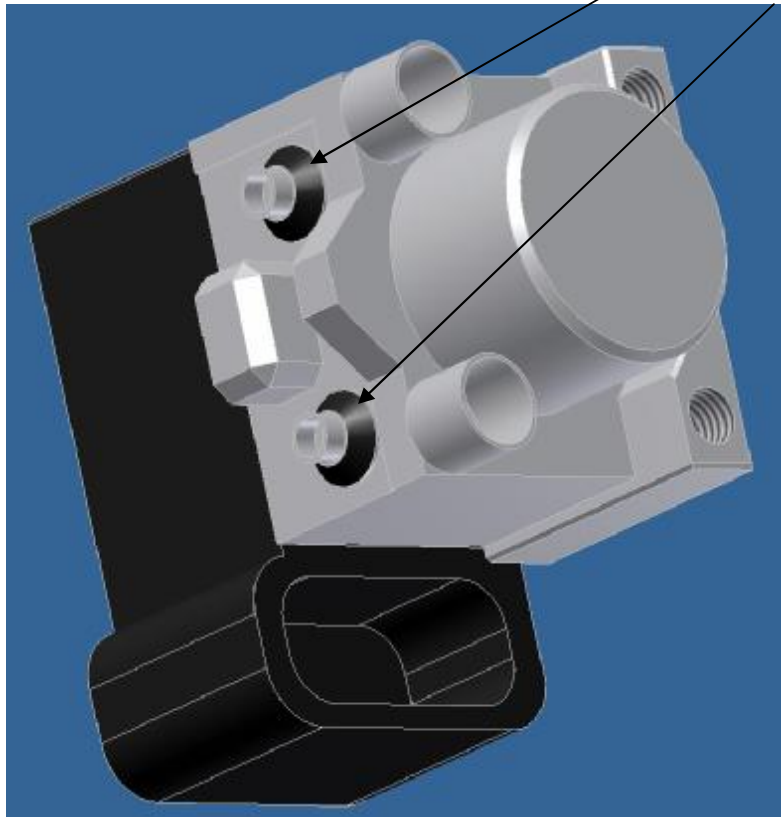

PASS

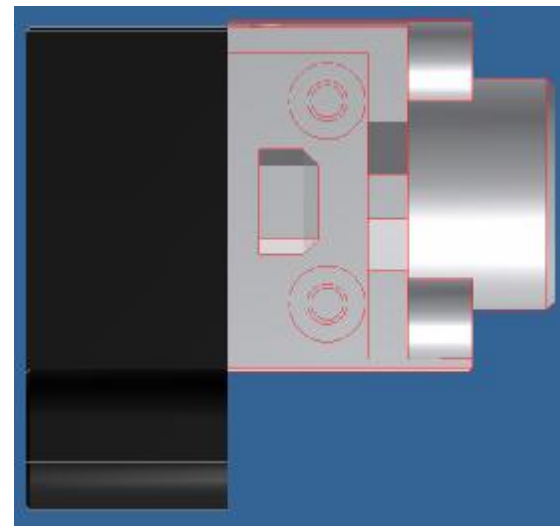

Fail





Design experience (Vision)

Hole Inspection

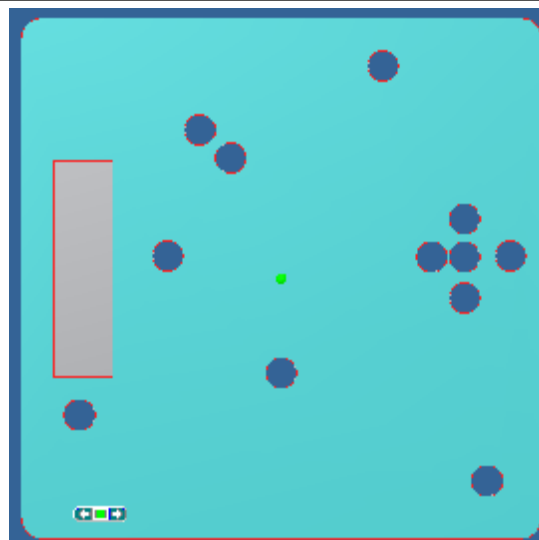

PASS

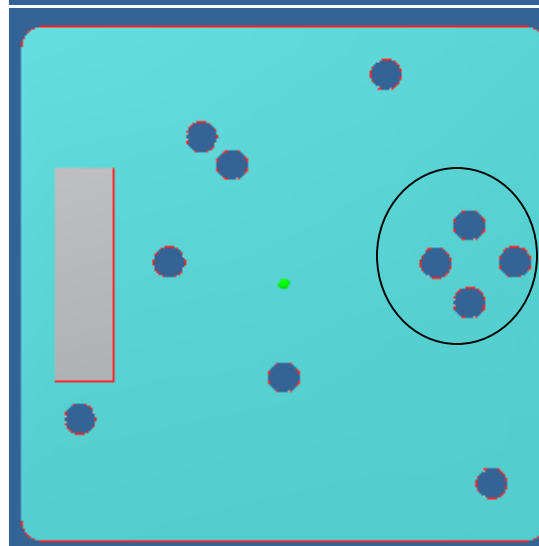

Fail



Design experience (Vision)

OCR

Original view



Capture view

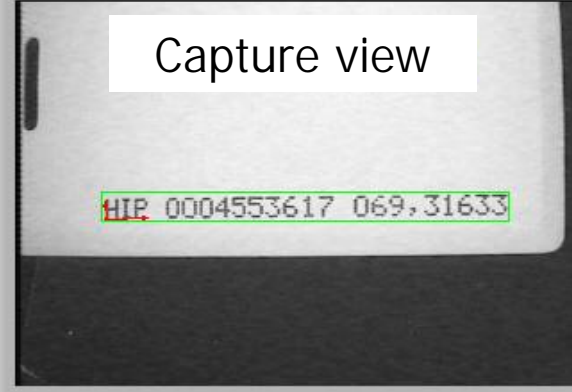

Read String → Read String: HIP0004553617069,31633 **READ STRING**

X1			X5
146.508			100.868
X	X2	X3	X4
100.868	147.797	100.868	99.6047
Y	Y2	Y3	Y4
271.96	269.378	271.96	248.995

stop
STOP



Production Machine List

No.	M/C Type	Brand	Model	Country	Accuracy/ Inc (micron)	Capacity	Qty.
1	CNC Machining center	AIA	XH714D	China	10	400*900MM	2
2	CNC Lathe	Guangzhou	G-CNC300J	China	10	Dia 300 x 500 mm	1
3	Wire cut machine	WEDM	DK7725e	Taiwan	10	200 x 200 x 150	1
4	Universal Cylindrical Grinding	YUNNAN	MY1420	China	5	Dia.200x600MM	1
5	Milling machine	ARCO	3H	Taiwan	20	W 12"* 40"	7
6	Lathe	Guangzhou	C6240BI	China	20	Swing 15" * 40"	1
7	Surface Grinding	ARCO	MYS7115	Taiwan	5	200*150MM	2
8	EDM	ECOWIN	MIC-432ACS	Taiwan	10	700*350MM	1

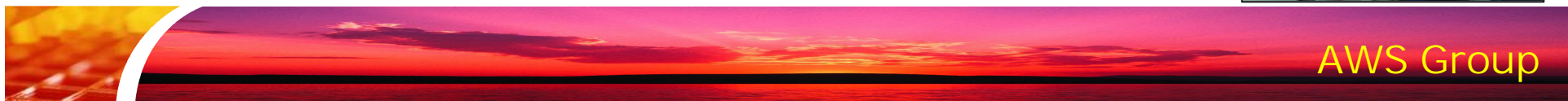



Quality Control Equipment

No.	M/C Type	Brand	Model	Country	Accuracy/ Inc (micron)	Capacity (Inch.)	Qty.
1	CMM 3D measuring machine	Chien Wei Precise Technology	CE-450 A	Tawan	1	400*450*250	1
2	Digital caliper	Mitutoyo	CD-6 CS	Japan	10	150	3
3	Digital caliper	Mitutoyo	CD-12 CS	Japan	10	300	2
4	Vernier high gage	Mitutoyo	PJ-3010F	Japan	10	100 x 200	1
5	Surface Plate	Mitutoyo	XXXX	Japan	5	725 x 975	1
6	Digital Electronic Micro meter	Mitutoyo	No.293-340	Japan	10	0-25.4	1
7	Profile Projector	Nikon		Japan	10	0-25.4	1
8	Hardness Tester			China	1 HRC		1



CMM



Profile Projector



Hardness Tester



Digital caliper



Micro Meter

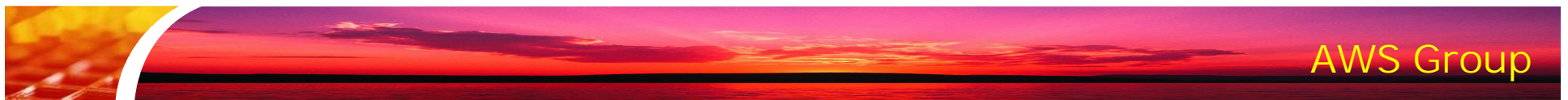



Fabrication experience



Ferrite m/c

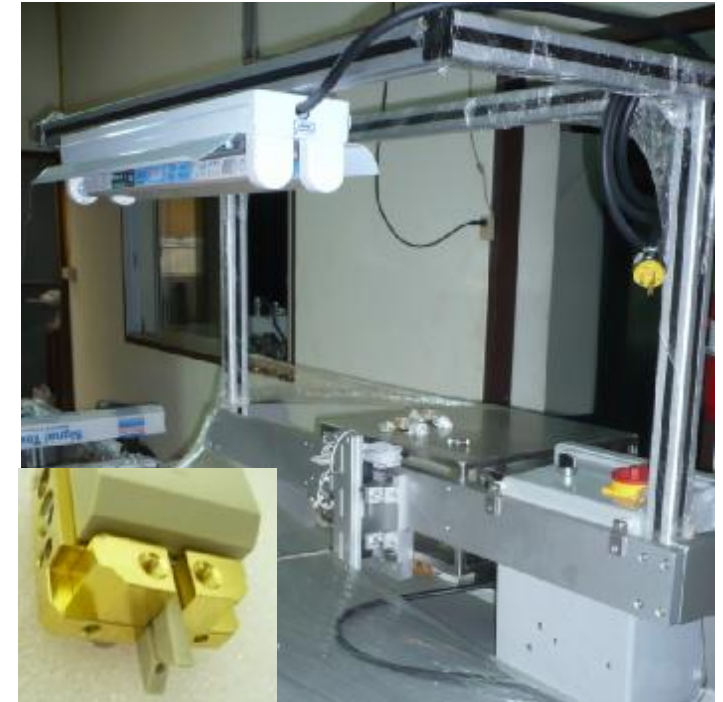

Auto bonding m/c



Fabrication experience

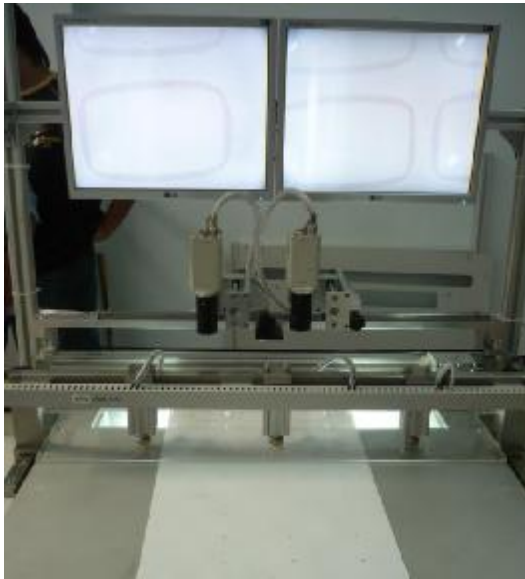

Edge cutting m/c



Nylon cutting m/c



Auto UV cure m/c

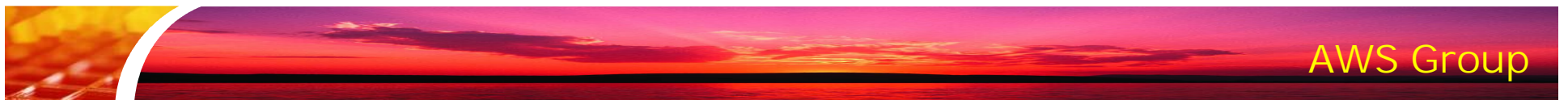



Fabrication experience



Pivot installation m/c



Card torsion m/c



Multiplexer equipment

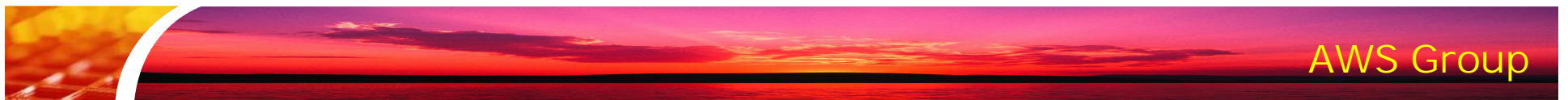



Fabrication experience



Box Text with wiring work



Industrial equipment supply

<p>Motion Control</p>	<p>Vision system</p>
<p>Electrical components/ sensor</p>	<p>Tools/equipment product</p>





Global network sourcing





Benefits to Customers

Time to market

- Reduced lead time for designing and production
- Leader of new technology and breakthrough in business.

Lower costs

- Automated or Semi automated processing
- Inventory reduction
- Faster throughput

Higher Quality

- Advanced product quality planning and process
- Use of stability, high volume processes

One Stop Service

- Design until validate prototype and spare part support
- Provide an on-site service with service mind staffs



Reference customers

- Western Digital
- Smartrac Technology
- Delta
- Belton
- Fabrinet
- Wave crest
- Compart precision
- dz card
- Suranaree university
- Nalco
- Nifco
- Siam Hitachi
- etc.